

Stairs & Railings

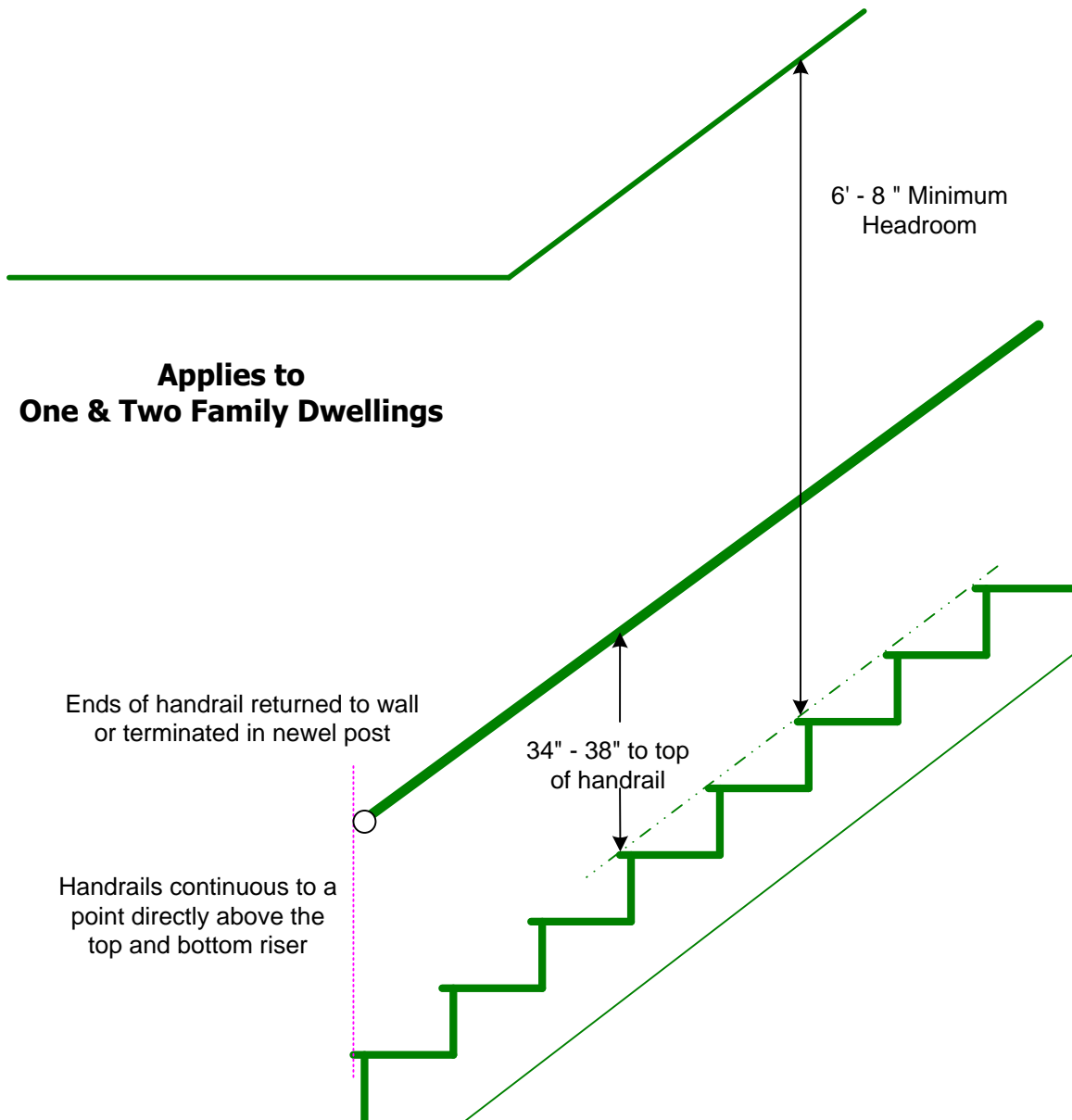

**Applies to
One & Two Family Dwellings**

TREADS and RISERS:

- Maximum riser is 7-3/4" and the minimum tread depth is 10". Risers and treads shall be uniform throughout flight.
- The greatest riser height shall not exceed the smallest by more than 3/8".
- The greatest tread shall not exceed the smallest by more than 3/8".
- The minimum headroom in all parts of the stairway shall not be less than 6' - 8" measured from a sloped plane adjoining the tread nosings.

HANDRAILS:

- Shall be continuous the full length of the stairs from a point directly above the top riser of a flight to a point directly above the lowest riser of the flight.
- A handrail is required on at least one side of stairs with four or more risers.
- The top of the handrail shall be placed not less than 34 inches and not more than 38 inches above the nosing of the treads.

Guards

Guards Required:

- Porches, decks, balconies, ramps or raised floor surfaces located more than **30 inches** above the floor or grade below shall have guards not less than **36 inches** in height.
- Open sides of stairs with a total rise of more than **30 inches** above the floor or grade below shall have guards not less than **34 inches** in height measured vertically from the nosing of the treads.

Guard Opening Limitations:

- Required guards shall have intermediate rails or ornamental closures that do not allow passage of a sphere **4 inches** in diameter.

Exceptions:

- The triangular openings formed by the riser, tread, and bottom rail of a guard at the open side of a stairway are permitted to be of such a size that a sphere **6 inches** in diameter cannot pass through.
- Openings for required guards on the sides of stair treads shall not allow a sphere **4 - 3/8 inches** to pass through.

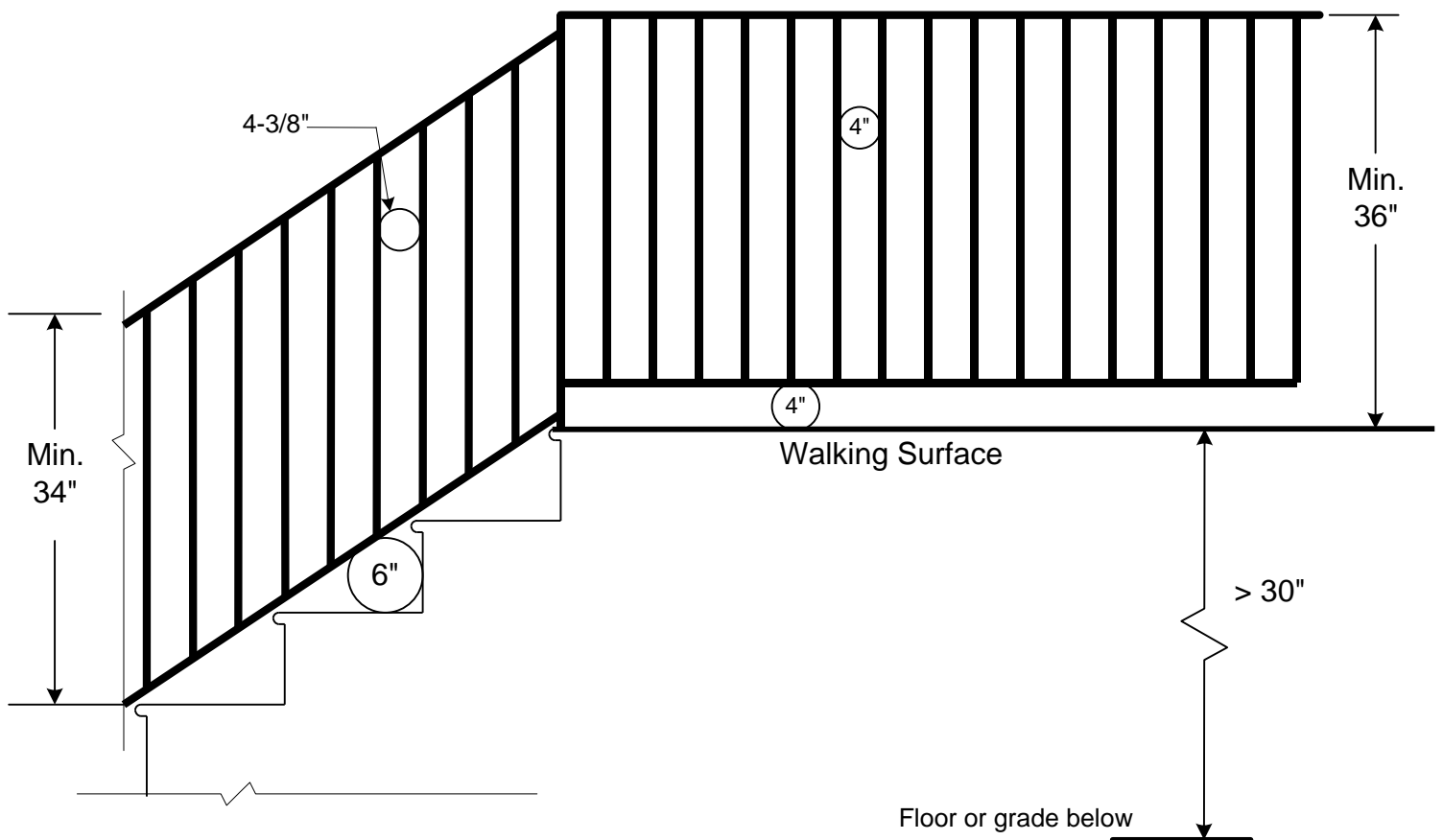

Handrails

Continuity:

Continuous handrail required the full flight of the stairs

Approved

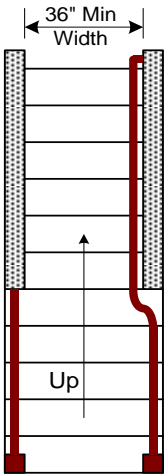

Handrail is not continuous
Not Approved

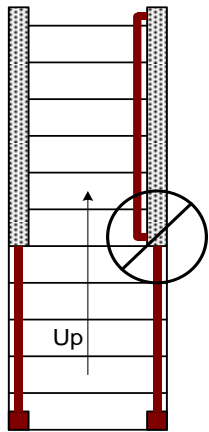

Handrail Detail

Handrails allowed to be interrupted at landing

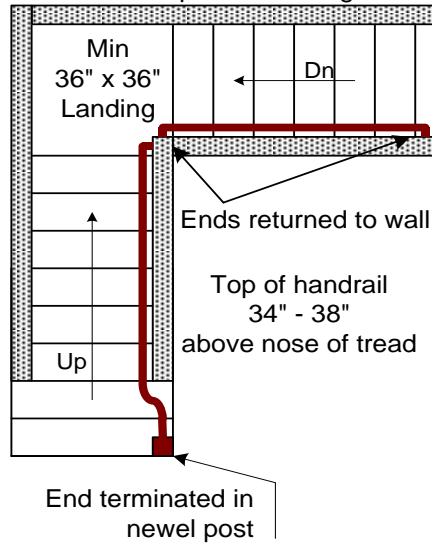

Winder Details

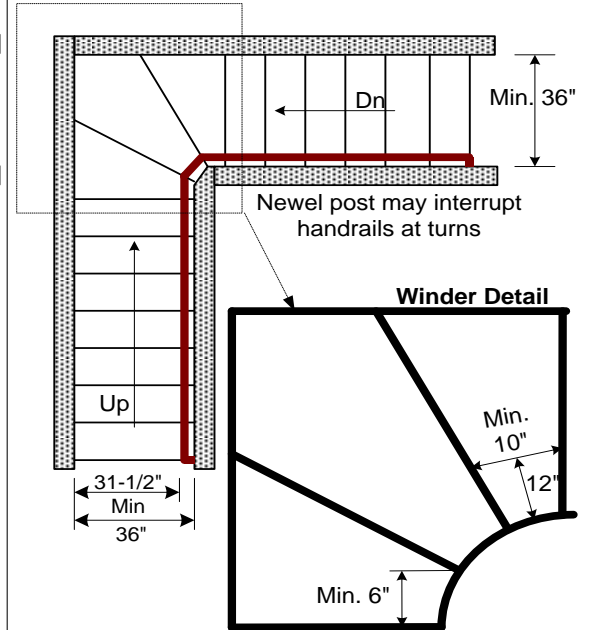

Clearance: 1-1/2" minimum between the handrail & wall

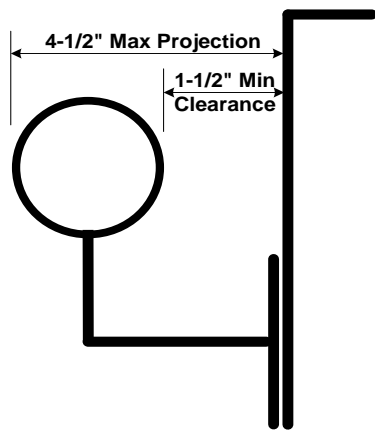

Approved Handrail Shapes

Other shapes may be acceptable if they provide equivalent graspability

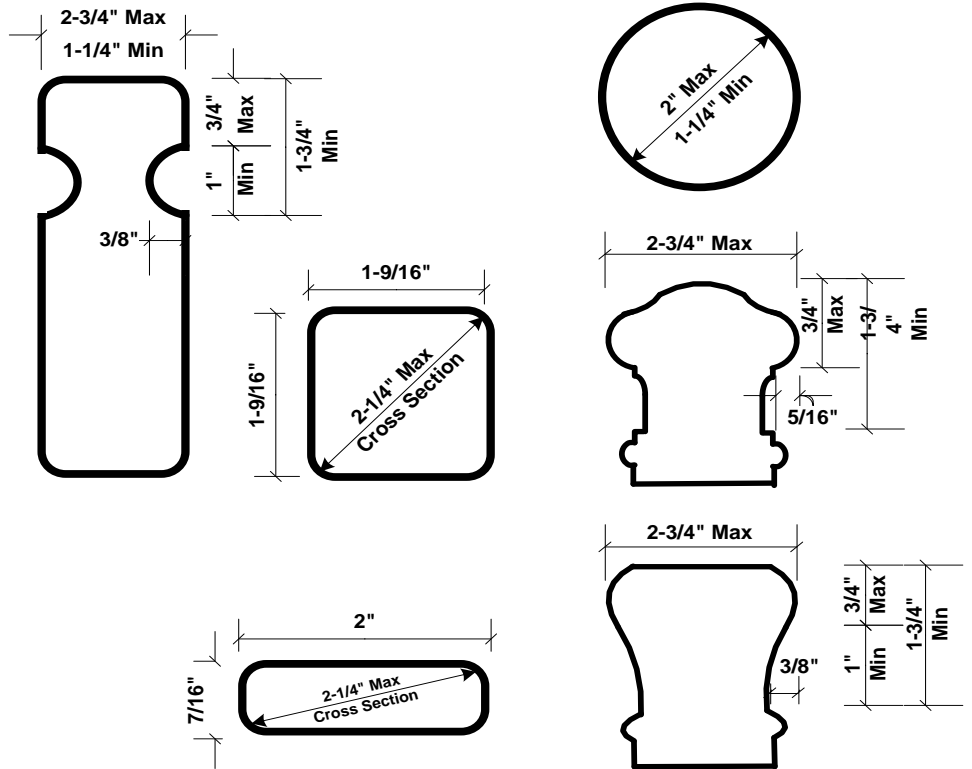

Not Approved Shapes

Flat 2 x 4

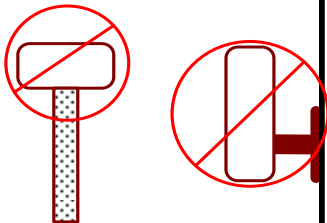

Tread Detail

Treads & Risers shall be uniform throughout flight

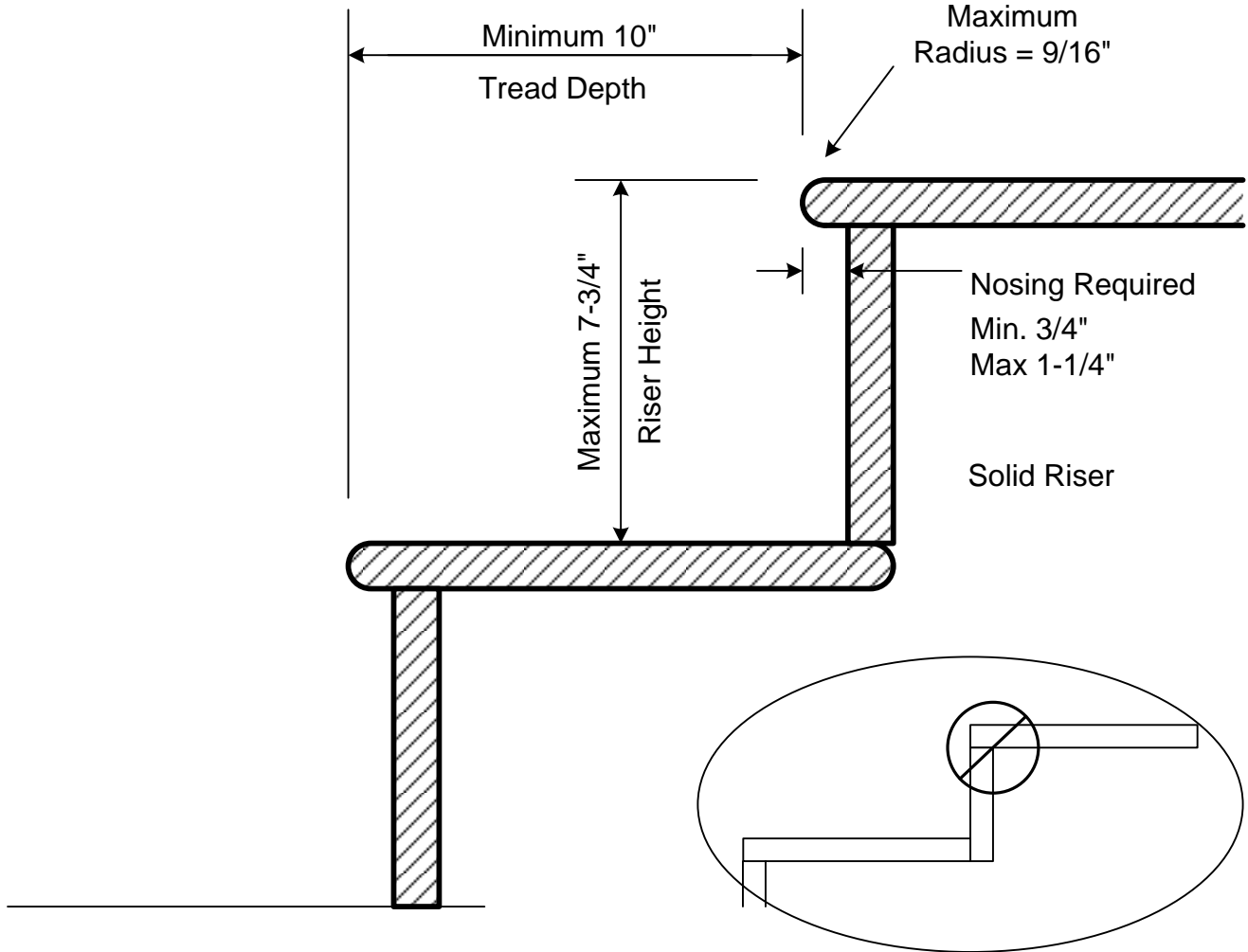

STAIR PROFILE:

NOSING REQUIRED:

- A nosing not less than 3/4" and not more than 1-1/4" shall be provided on stairs with solid risers.
- The greatest nosing projection shall not exceed the smallest by more than 3/8 inch.
- A nosing is not required where the tread depth is a minimum of 11 inches.

RISERS:

- Risers shall be solid or
- May be open risers if the opening between treads does not permit the passage of a 4" diameter sphere.